

Всяко кръгче отговаря за сричка в думата. Оцвети сричките,
в които се чува звук „Е“.

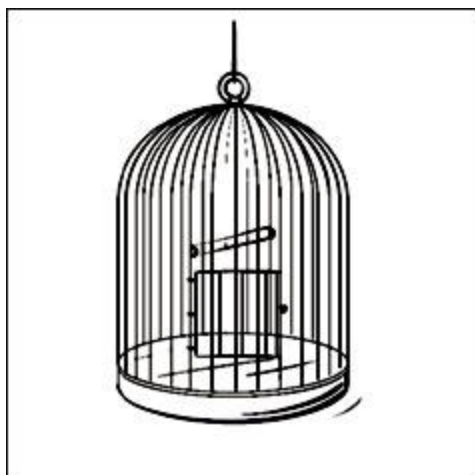

○ ○

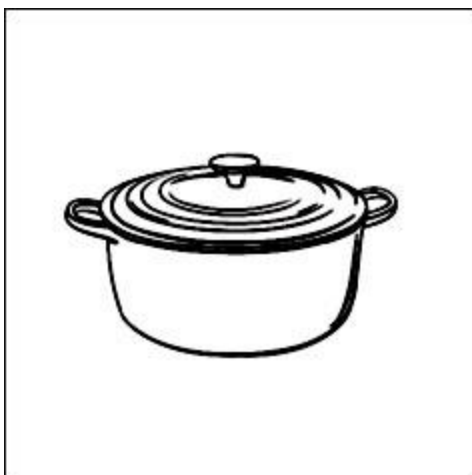

○ ○ ○

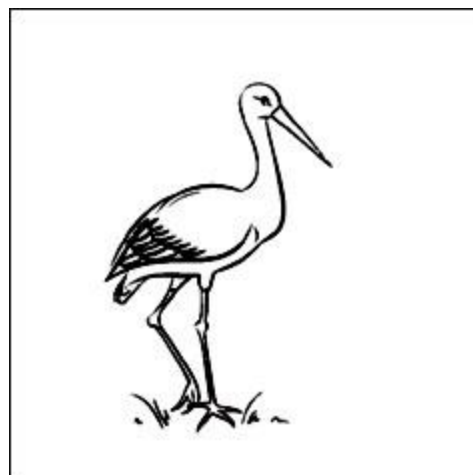

○ ○

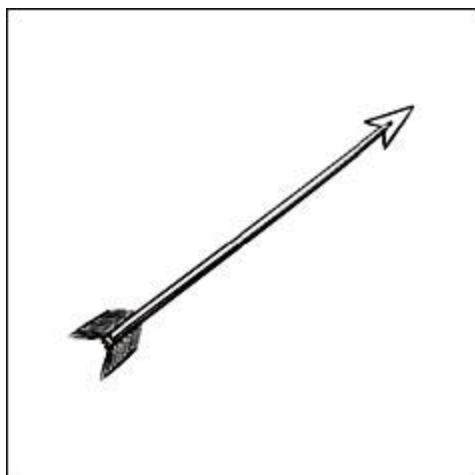

○ ○

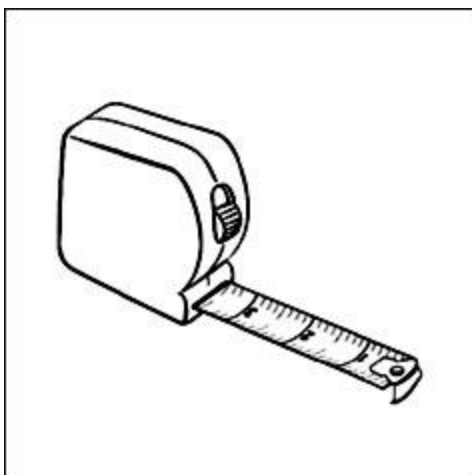

○ ○ ○

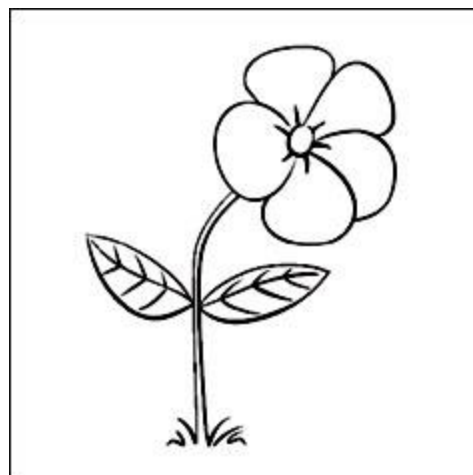

○ ○



○ ○ ○



○ ○



○ ○ ○

Всяко кръгче отговаря за сричка в думата. Оцвети сричките, в които се чува звук „И“.



○ ○ ○

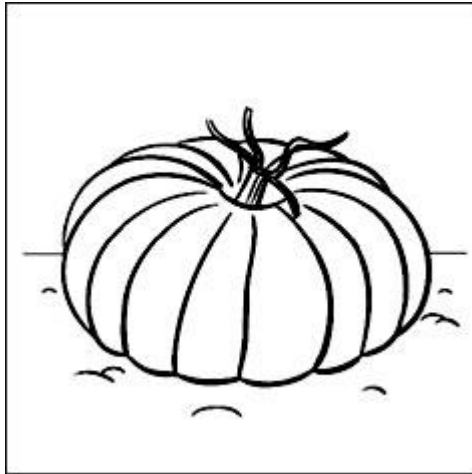

○ ○

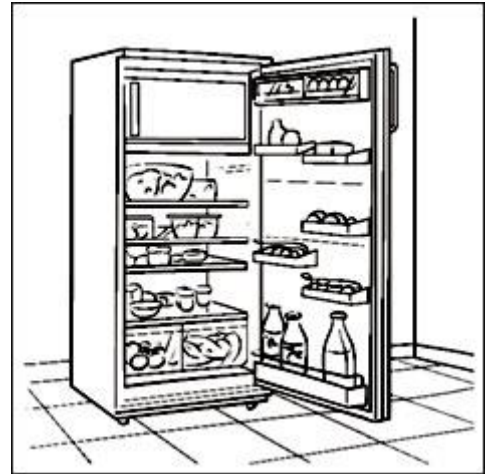

○ ○ ○

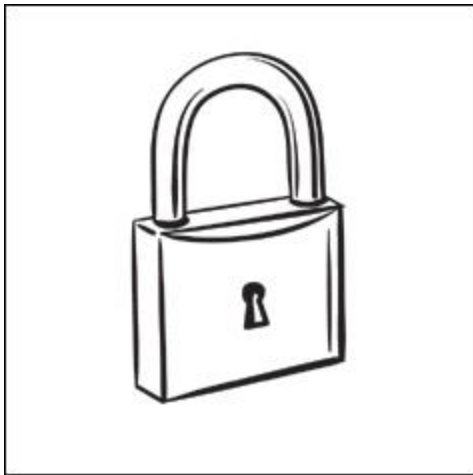

○ ○ ○

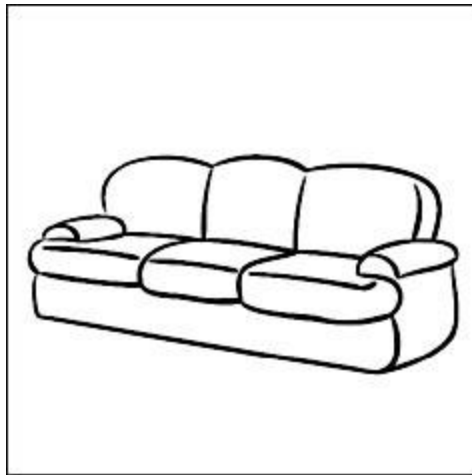

○ ○

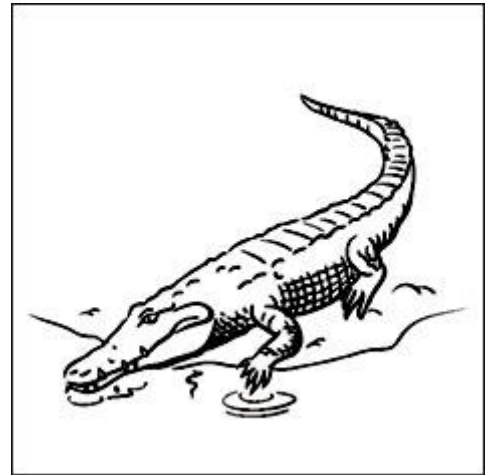

○ ○ ○

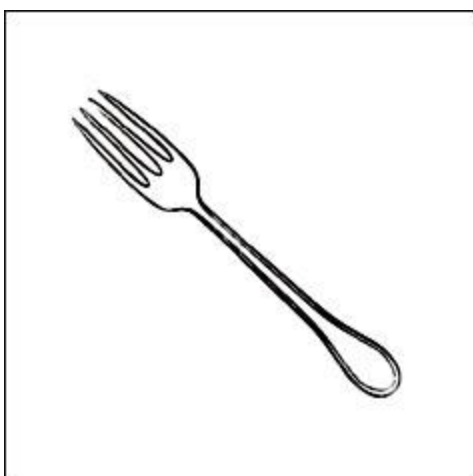

○ ○ ○

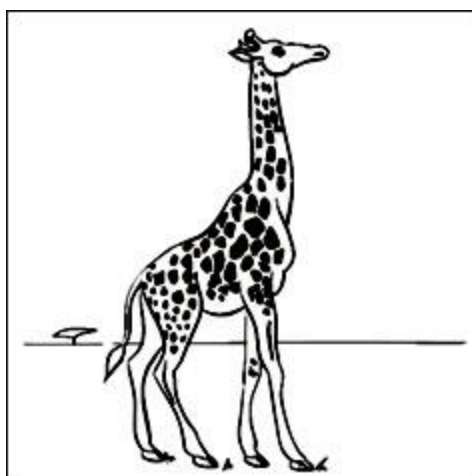

○ ○



○ ○ ○